



JAPAN ENERJUMP Co., Ltd.

2-14-12 KW build.4F, Nihonbashi-kakigaracho, Chuo-ku, Tokyo 103-0014 JAPAN

TEL: 03-6661-1807 FAX: 03-5651-3213

<http://www.enerjump.co.jp/> E-mail: info@enerjump.co.jp

POWER SERIES
The Power of Dreams





**Japan Standard
Japan Quality**

Accurate
Convenient
Secure

We provide 'TOP
SERVICES AND HIGH
QUALITIES' for all of our
customers.



JAPAN ENERJUMP
Gear Pump JGP-50
Flow Rate: 50L/min
Max. Pressure: 0.2Mpa
www.enerjump.co.jp

• **POWER SERIES**

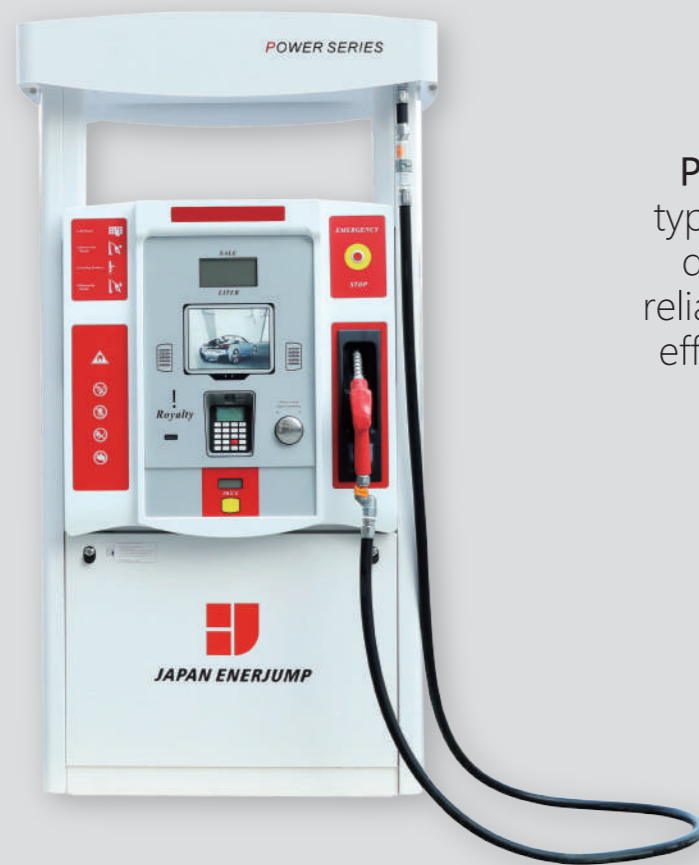
NO DETAIL NO SUCCESS

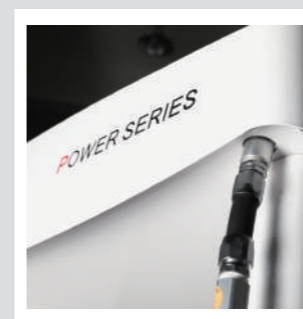

POWER SERIES is the type with highest design, quality, durability and reliability that contains the effort of our entire staffs sufficiently.



• POWER SERIES

Top Performance from POWER SERIES

POWER SERIES provides good service for both gas stations and drivers, which is the necessary dispenser for all.



Wide Range of Product Lineup

The Lineup of POWER SERIES meets various requirements of stations and customers. Choose the one that fits your needs.



Stylish Counter Area

Counter Area is assembled with Fiber Glass display panel that is designed with humanization and fashion. Customers can upgrade functions such as JEJ IC card system, printer, etc.

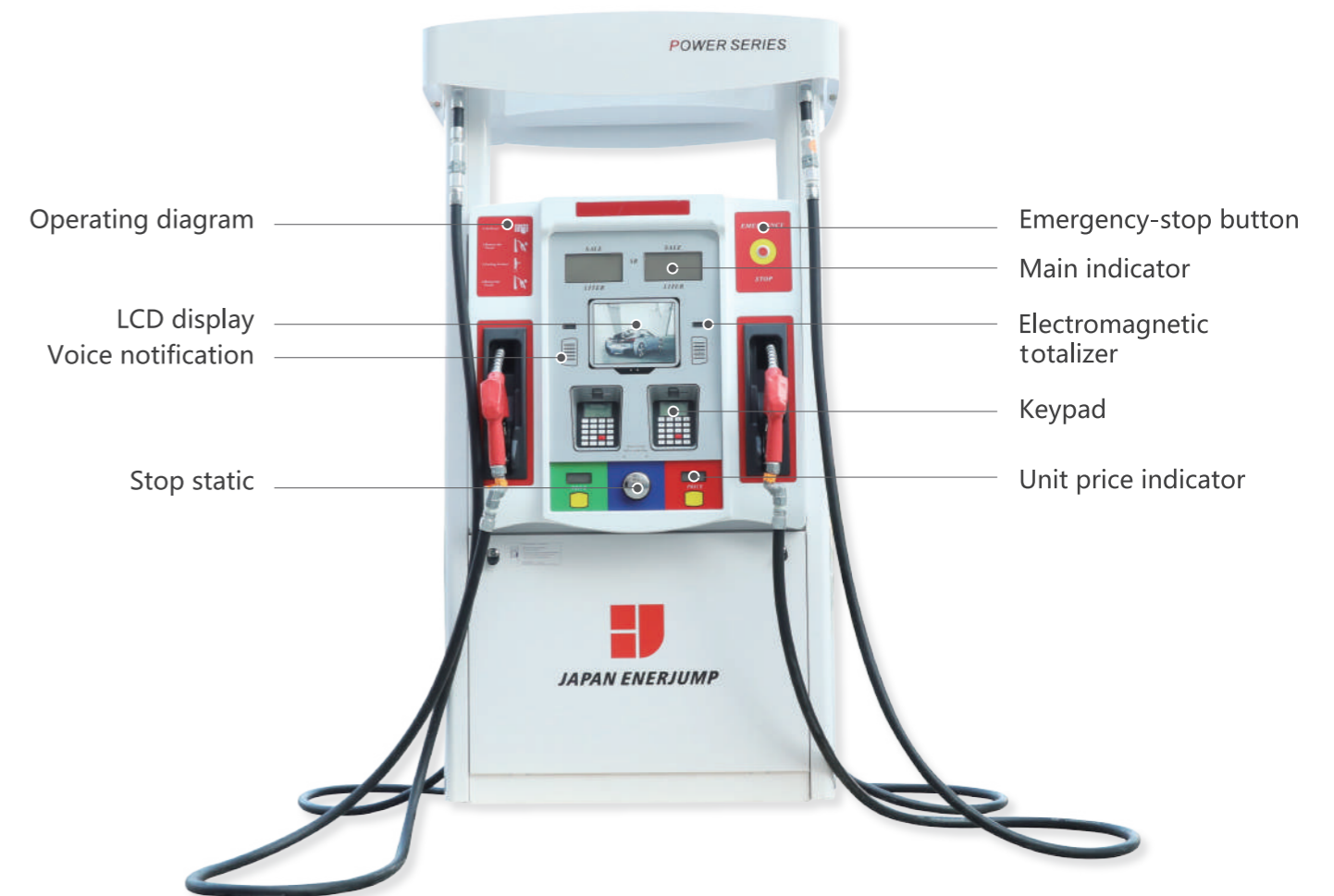

• POWER SERIES

Enhanced Counter Display

The display with backlight LED is visible under any circumstances. Far more, the upgraded 8-digit readout can tackle with any currency in the world.

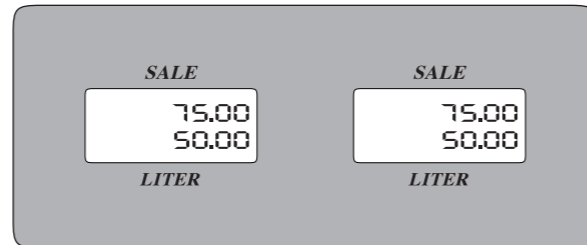

Handling Smoothly

With the upgradation of all hanging hardware, including nozzle, breakaway, hose and swivel, all actions of refueling can be done easily. The plastic type nozzle holder fits the nozzle perfectly and achieves high durability. The safety breakaway coupling cover prevents damage to dispenser in unpredicted situation.



Components with High Performance

We request every components and assembly process strictly and ensure every components can do their best for our customers.

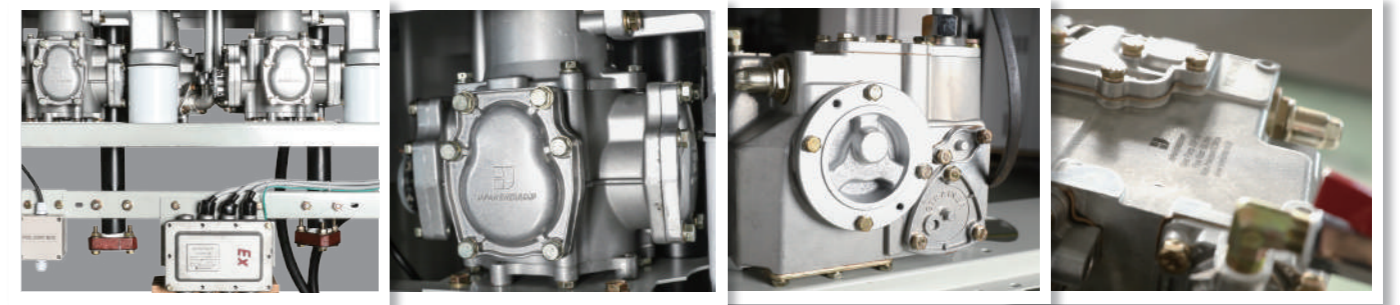



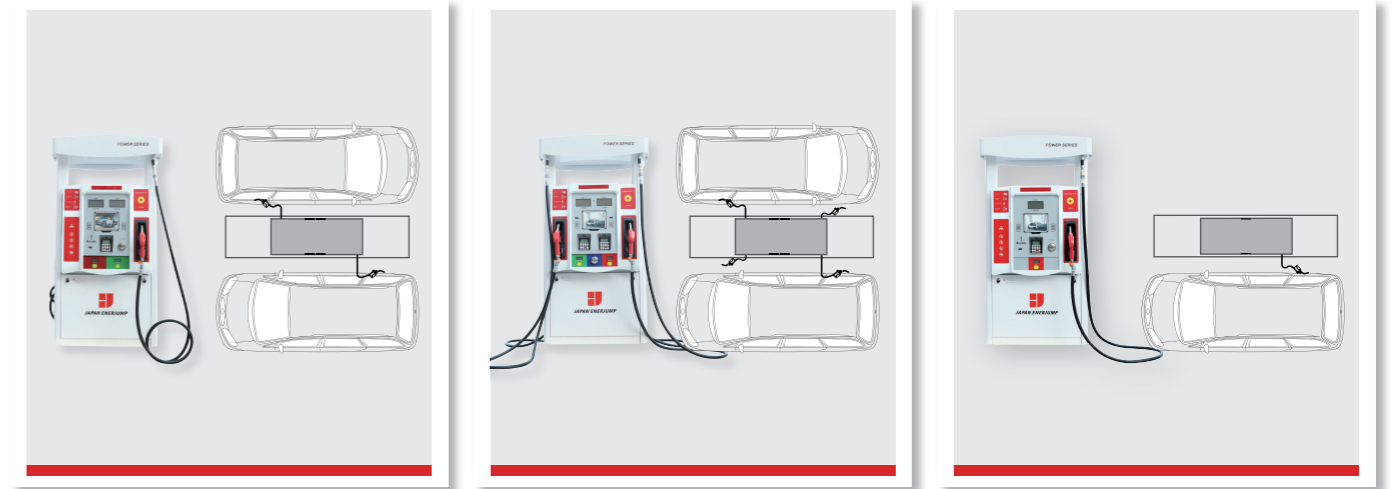

Wide Variety of Options

We provide a wide range of options for our customers. You can customize the dispenser so that it fits the best needs of you and your customers.

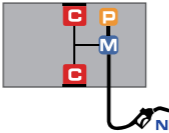
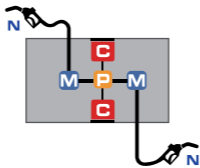
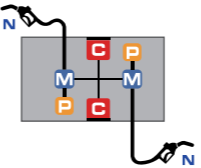
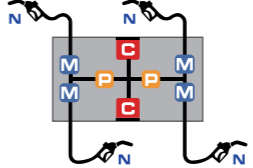
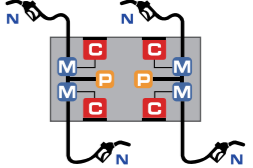

List of Functions

		List of Functions/Models				
Model Suction		PRGO1111	PRGO2121	PRGO2221	PRGO4241S	PRGO4241
Apperance						
Fueling system diagram	<ul style="list-style-type: none"> P P- Pump M M-Meter C C- Counter N N- Nozzle 					
Fiber glass display panel		○	○	○	○	○
Monitor		△	△	△	△	△
Pos preset		△	△	△	△	△
Keypad with display		○	○	○	○	○
Hose 13ft (Hard)		○	○	○	○	○
Hose hanger		△	△	△	△	△
Nozzle	Auto-stop nozzle	○	○	○	○	○
	High speed nozzle	△	△	△	△	△
	Ultra-high speed	△	△	△	△	△
Nozzle holder	Al	○	○	○	○	○
	Plastic	△	△	△	△	△
Swivel		△	△	△	△	△
Safety breakaway coupling		○	○	○	○	○
Safety breakaway coupling cover		△	△	△	△	△
Sight glass		△	△	△	△	△
Emergency-stop button		○	○	○	○	○
Static electricity discharge pad		△	△	△	△	△
Bulit-in printer		△	△	△	△	△
LED poster		△	△	△	△	△
JEJ IC card system		△	△	△	△	△

■ Dimensions

PRGO1111

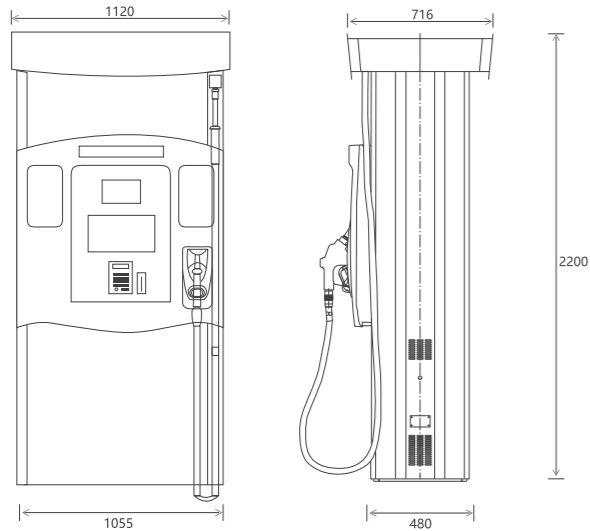

PRGO2121/PRGO2221

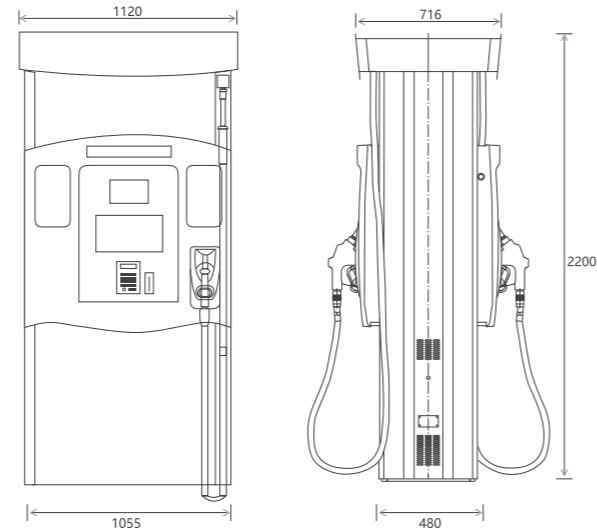

PRGO4241

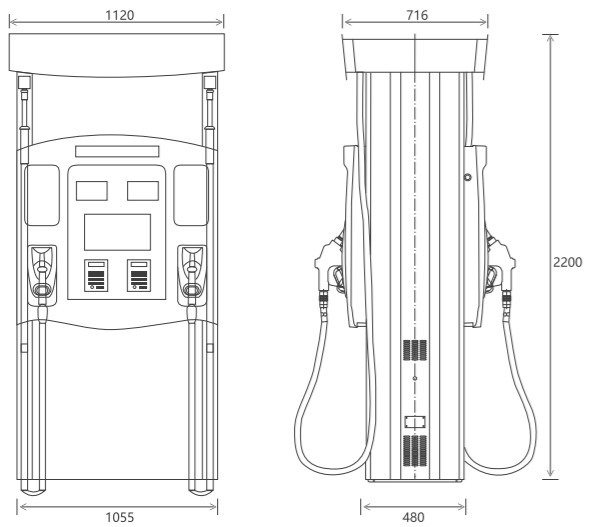

PRGO4241S

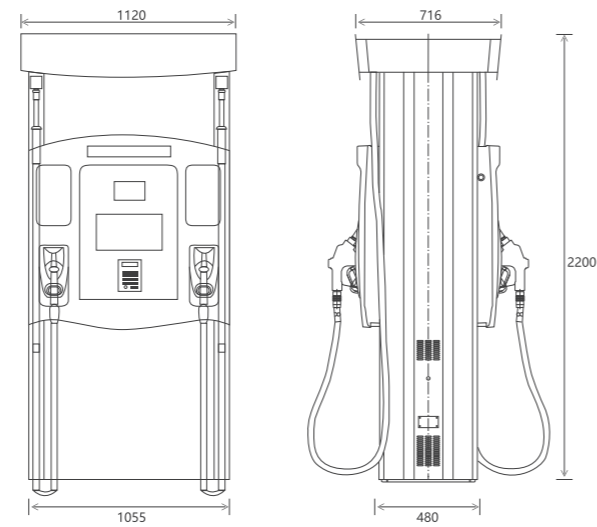

Voice notification

Stop static

Electromagnetic totalizer

Keypad

main indicator

Emergency-stop button

■ Main Specifications

	Suction Pump Type	Submersible Turbine Pump (STP)Type
Flow Rate	Normal:50L/min High:70L/min Ultra-high:90L/min	Depends on the on-site STP capacity
Pump	Internal silent gear pump with air separator Suction strainer, Flexible pipe By-pass valve and Suction check valve	
Flexible Pipe	Flange type, 1-1/2" threaded	
Maunal Drive Handle	Provided for maunal operation during power failure	
Motor	Three-phase 380V 750W (Optional)Single-phase 220-240V 750W	
Meter	4-piston positive displacement flowmeter with electronic adjust er	
Accuracy	±0.3%	
Counter	Type	LCD
	Character Color	Black charactors on a blue field with bright LED back light (Optional)White/Yellow/Orange back light
	Display	Sale: 8 digits[0.01~999,999.99] Liter:8 digits[0.01~999,999.99] Unit Price:5 digits[0.01~999.99]
		Electromagnetic Totalizer
	Electronic Totalizer	(Optional) 8 digits
	Other Funtions	Battery back-up (Optional) Self-diagnosis (Optional) Over voltage protector
Reset Device	Automatic reset	
Nozzle	Automatic nozzle, Spout outside diameter 21mm, 25mm	
Hose	Black color hose, Oil resistance type, Inside diameter 16mm (Optional)Red/Yellow/Green color hose	
Safty Breakaway Couping	Provided	
Wiring	(Optional)Cabtyre cable	
Emergency Stop Switch	Provided	
POS Interface	(Optional)	
Line Fuel Filter	(Optional)	
Anti Static Touch Pad	(Optional)	
Sight Glass	(Optional)	
Receipt Printer	(Optional)	
AD Display	(Optional)	
LED Message Board	(Optional)	
Ambient Temperature	-40 to+ 60 °C	
Noise	≤80dB (A)	
Inlet Vacuum	≥0.06MPa	

Note: The delivery speed of the pump may change due to the following conditions if it is used beyond JEJ's installation and operational instructions:

- 1) Size and length of hose
- 2) Size and type of nozzle/swivel
- 3) Type of oil product, suction conditions, and local piping conditions
- 4) With/without presets

Specifications are subject to change with or without prior notice.

- POWER SERIES is assembled with the reliable and efficient components that add powerful benefit to your business.
We deliver 'Japan Quality Japan Standard' dispensers to you.



 We reserve the right to change the specifications and designs for improvement without prior notice.